



BOSCH

User guide

Air/water heat pump

Compress 7000 AWM/AWMS 5-17

Heat pump with indoor unit

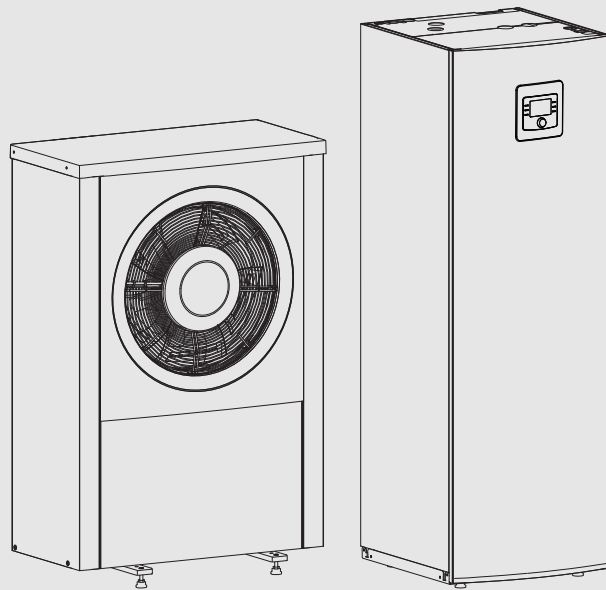

Table of contents

1	Explanation of symbols and safety instructions	3
1.1	Explanation of symbols	3
1.2	General safety instructions	3
1.2.1	Intended use	3
2	Product description	4
2.1	Typeplate	4
2.2	Declaration of Conformity	4
2.3	Heat pump (outdoor unit)	4
2.3.1	Operating range of heat pump without auxiliary heater	4
2.3.2	Generic overview of the refrigerant circuit	5
2.4	Indoor unit	5
2.5	Hints on energy saving	5
3	Operation	6
3.1	Control unit	6
3.1.1	Operation after power failure	6
3.1.2	Overview of control elements and symbols	6
3.2	Control panel	7
3.2.1	Switching off	7
3.2.2	Selecting a heating circuit for the standard display	7
3.2.3	Set operating mode	8
3.2.4	Changing the room temperature temporarily	8
3.2.5	Changing the room temperature permanently	8
3.2.6	Adapting the heating system settings using the time program (automatic mode)	8
3.2.7	Selecting active time program for the heating system	9
3.2.8	Renaming a time program or heating circuit	10
3.2.9	DHW settings	10
3.2.10	Setting up a holiday program	11
3.2.11	More settings	12
3.3	Main menu	12
3.3.1	Heating settings	12
3.3.2	DHW settings	13
3.3.3	Settings for the venting function	15
3.3.4	Setting up a holiday program	15
3.3.5	Settings for other systems or devices	15
3.3.6	General Settings	16
3.4	Calling up information about the system	17
3.5	Faults	18
4	Maintenance	19
4.1	Indoor unit	19
4.1.1	Check system pressure	19
4.1.2	Particle filter	19
4.1.3	Overheating protection	20
4.1.4	Moisture in cooling mode	20
4.1.5	Checking the safety valves	20
4.2	Heat pump (outdoor unit)	20
4.2.1	Housing (casing)	20
4.2.2	Evaporator	20
4.2.3	Snow and ice	20
4.2.4	Cleaning of the condensation catch pan	21
4.3	Connection option for the IP module	22

4.4	Information on refrigerant	22
5	Environmental protection and disposal	23
6	Data Protection Notice	23
7	Technical terms	23
8	Overview Main menu	25
9	Overview Info	26

1 Explanation of symbols and safety instructions

1.1 Explanation of symbols

Warnings

In warnings, signal words at the beginning of a warning are used to indicate the type and seriousness of the ensuing risk if measures for minimizing danger are not taken.

The following signal words are defined and can be used in this document:

 **DANGER**
DANGER indicates that severe or life-threatening personal injury will occur.

 **WARNING**
WARNING indicates that severe to life-threatening personal injury may occur.

 **CAUTION**
CAUTION indicates that minor to medium personal injury may occur.

NOTICE
NOTICE indicates that material damage may occur.

Important information

 The info symbol indicates important information where there is no risk to people or property.

Additional symbols

Symbol	Meaning
▶	a step in an action sequence
→	a reference to a related part in the document
•	a list entry
–	a list entry (second level)

Table 1

1.2 General safety instructions

1.2.1 Intended use

The heat pump must only be used as a heat appliance in a sealed heating water system for domestic purposes and according to EN 12828. Any other use is considered inappropriate. Any damage that results from such use is excluded from liability.

Safety of electrical devices for domestic use and similar purposes

The following requirements apply in accordance with EN 60335-1 in order to prevent hazards from occurring when using electrical appliances:

“This appliance can be used by children of 8 years and older, as well as by people with reduced physical, sensory or mental capabilities or lacking in experience and knowledge, if they are supervised and have been given instruction in the safe use of the appliance and understand the resulting dangers. Children shall not

play with the appliance. Cleaning and user maintenance must not be performed by children without supervision.”

“If the power cable is damaged, it must be replaced by the manufacturer, its customer service department or a similarly qualified person, so that risks are avoided.”

Inspection and maintenance

Regular inspection and maintenance are prerequisites for safe and energy efficient operation of the heating system.

We recommend you enter into a contract for the annual inspection and demand-dependent maintenance with an authorised installer.

- ▶ Have work carried out only by an approved installer.
- ▶ If any faults are discovered, have them remedied immediately.

Inspection and maintenance

If there is a lack of cleaning, inspection or maintenance, or if these are carried out incorrectly, this may result in material damage and/or personal injury, including possible loss of life.

- ▶ Have work carried out only by an approved contractor.
- ▶ Do not take off the heat pump cover.
- ▶ Do not modify the heat pump or other parts of the heating system.

Room air

The air in the installation room must be free of combustible or chemically aggressive substances.

- ▶ Do not use or store combustible or explosive materials (paper, propellants, thinners, paints, etc.) within the vicinity of the appliance.
- ▶ Do not use or store corrosive substances (solvents, adhesives, chlorinated cleaning agents, etc.) within the vicinity of the appliance.

Damage caused by frost

The solar system can freeze if it is switched off:

- ▶ Observe the notices regarding frost protection.
- ▶ Due to the additional functions, e.g. DHW heating or pump anti-seizure protection, the system should always be left on.
- ▶ Correct any faults immediately.

Risk of scalding at the DHW draw-off points

- ▶ If DHW temperatures above 60 °C are set or if thermal disinfection is activated, a mixer must be installed. If in doubt, ask your installer.

2 Product description

This is an original manual. This manual may not be translated without the approval of the manufacturer.

The heat pump Compress 7000 AW is together with the indoor units AWM, AWMS part of a series of heating systems that use outside air to provide energy for water transferred heat and hot water. By reversing the process and extract heat from the water and release it into the outdoor air, the heat pump can if needed produce cooling. This however requires the heating system to be set up for cooling.

The heating system is operated via a user interface, which is found in the indoor unit. The user interface manages and supervises the system with different settings for heat, cold, hot water and other operations. The monitoring function will e.g. turn off the heat pump in case of disturbances to avoid damage to vital components.

2.1 Typeplate

- Compress 7000 AW: The typeplate is located on the backside of the heat pump.
- AWM / AWMS: The type plate is located on the top cover of the indoor unit.

On the type plate there are information about output power, article number, serial number and date of manufacturing.

2.2 Declaration of Conformity

The design and operating characteristics of this product comply with the European and national requirements.

 The CE marking declares that the product complies with all the applicable EU legislation, which is stipulated by attaching this marking.

The complete text of the Declaration of Conformity is available on the Internet: worcester-bosch.co.uk.

2.3 Heat pump (outdoor unit)

The heat pump is inverter operated, which means that it will automatically change the compressor speed to deliver the exact amount of energy required at the moment. The fan is also RPM controlled and will change its speed as needed. This provides the lowest possible energy consumption.

The speed changes have an effect on the sound emissions, as higher speed results in higher sound emission.

Defrosting

Ice might form on the evaporator during lower outside temperatures. In case there is enough ice to inhibit the air flow through the evaporator, an automatic defrosting will start. As soon as the ice is gone, the heat pump returns to its normal operation.

If the outside temperature is above +5 °C the defrosting will be performed alongside continued heat production, however if the temperature is lower, the defrosting is done by ways of a 4-way valve turning the heat medium direction in the circuit so that the hot gas from the compressor melts away the ice. The duration of the defrost cycle depends on the actual outdoor temperature and the amount of frost on the evaporator.

2.3.1 Operating range of heat pump without auxiliary heater



The heat pump switches off at approx. -20 °C or $+35\text{ °C}$. The indoor unit or an external heat source then take over the heating and DHW heating. The heat pump restarts if the outdoor temperature exceeds roughly -17 °C or falls below $+32\text{ °C}$. In cooling mode the heat pump switches off at roughly $+45\text{ °C}$ and restarts at roughly $+42\text{ °C}$.

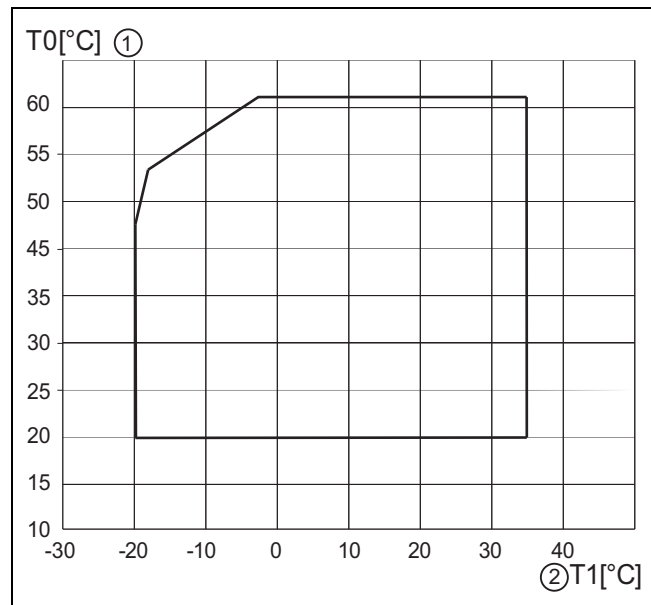

Fig. 1 Heat pump without auxiliary heater

[1] Maximum flow temperature (T0)

[2] Outdoor temperature (T1)

2.3.2 Generic overview of the refrigerant circuit

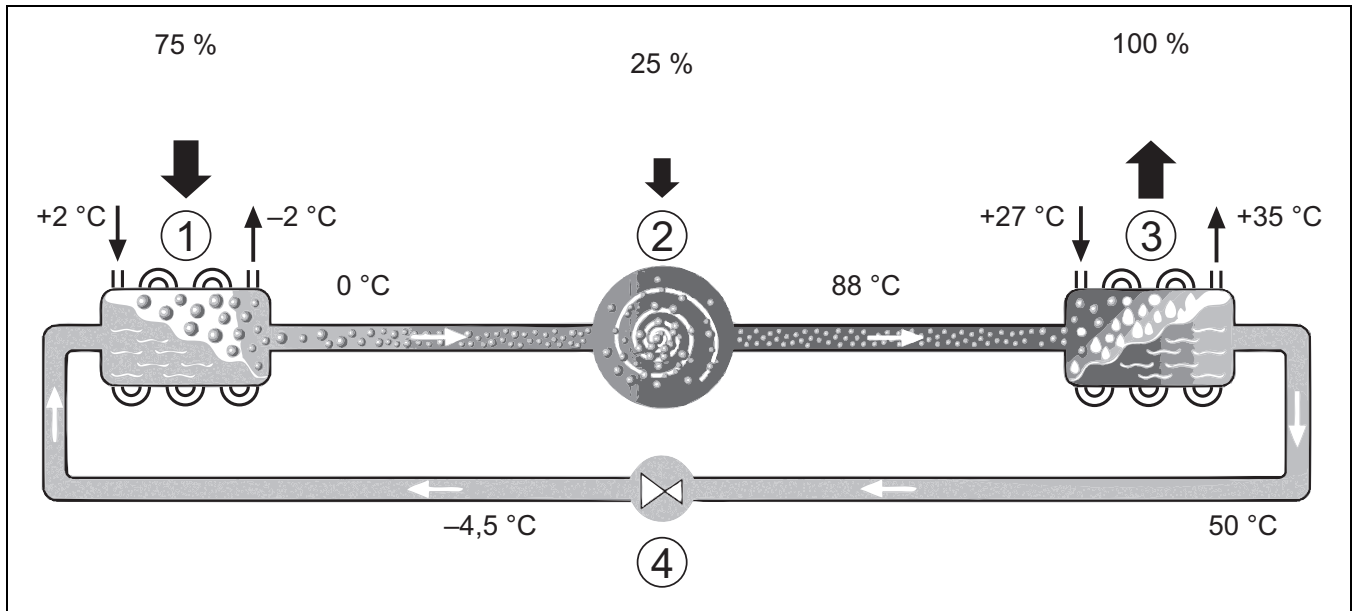

Fig. 2 Functional principle of the refrigerant circuit in the heat pump

- [1] Evaporator
- [2] Compressor
- [3] Condenser
- [4] Expansion valve

This booster heater is integrated, and its on/off is controlled by the user interface in the indoor unit. Please note that when the heat pump is running, the booster heater will only provide the heating output that the heat pump cannot produce itself. When the heat pump is able to provide all the heating needed, the booster is automatically turned off.

2.4 Indoor unit

The task of the indoor unit is to distribute the heat from the heat pump to the heating system and the hot water cylinder. The circulation pump in the indoor unit module is RPM controlled, and will automatically decrease in speed when demand is low. This decreases energy consumption. When the heating demand is higher during cold outdoor temperatures, an additional heat source - a booster - may be required.

AWM / AWMS

Heat pump Compress 7000 AW connected with the indoor unit AWM or AWMS provides a complete installation for both heating and domestic hot water, since the indoor unit contains a DHW cylinder. Switching between heating and DHW is managed by an internal 3-way valve. The integrated booster heater in the indoor unit will turn on if needed.

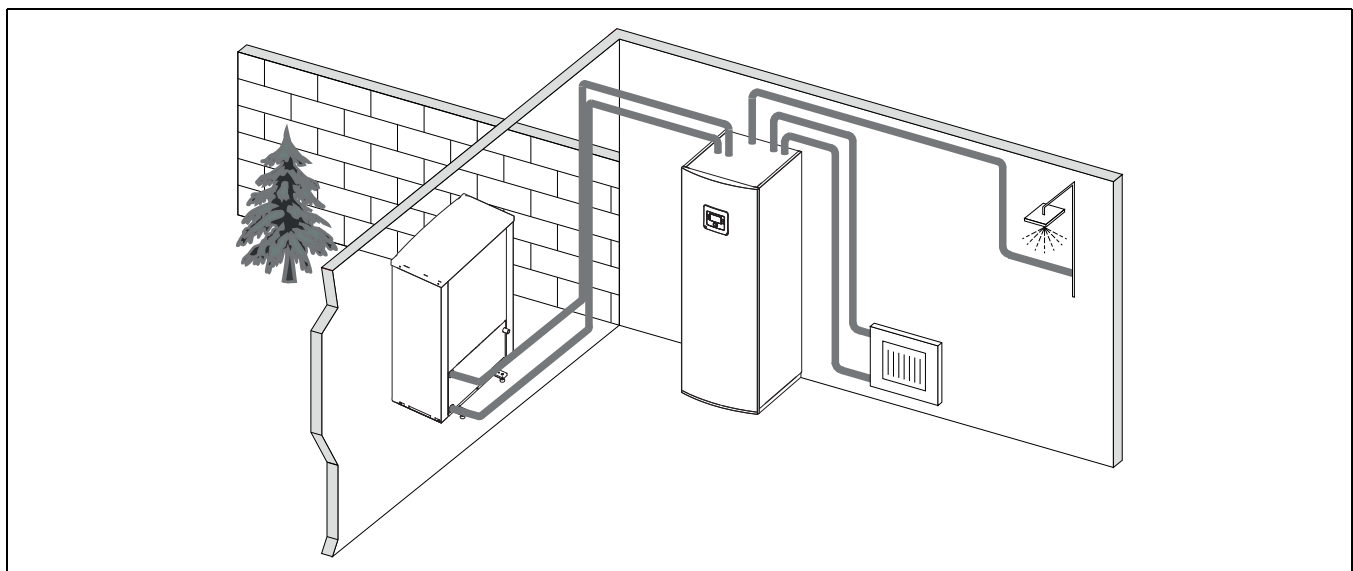

Fig. 3 Heat pump Compress 7000 AW, indoor unit AWM / AWMS with integrated DHW cylinder and booster heater

2.5 Hints on energy saving

- Use the normal heating mode, thus the heating system will use the least energy. Set the desired room temperature according to your personal comfort needs.
- Open the thermostatic vents fully in all rooms. Increase the temperature setting on the control only when the desired room temperature has not been reached for some time. Close the thermostatic valve in a specific room, only if that room is warmer than the others.
- If there is a room controller installed, this can be used to set the optimal room temperature. Avoid influence of external heating (i.e. sunlight or wood stove). Otherwise unwanted fluctuations in the room temperature may occur.
- Avoid placing big objects i.e. a sofa in front of the radiators (minimum 50 cm distance). This will block the circulation of the heated air in the room.
- Do not set a too low temperature for cooling. Cooling will also consume energy.

Vent the room correctly

Open the windows fully for a short period instead of leaving them ajar. Leaving the windows ajar will let the heated air out of the room constantly without increasing the air quality. Close the thermostatic valves or lower the heating setting on the room controller while the room is vented.

3 Operation



WARNING

Material damage from frost!

The heating or auxiliary heater may be irreparably damaged by frost.

- ▶ Do not start the indoor unit if there is a possibility of the heating or auxiliary heater being frozen.

3.1 Control unit

The user interface HPC 410 controls max. 4 heating circuits individually in one of the respective control modes:

- **Outdoor-temp.-compensated**
 - the flow temperature is adjusted based on the outside temperature according to an optimised heating curve.
- **Outdoor-temp.-compensated with low end¹⁾**
 - the flow temperature is adjusted based on the outside temperature according to a simplified heating curve.

For both of the control modes a room controller may be installed in the reference room to allow the influence of the measured and required room temperature. The heating curve is then adjusted accordingly.



The user interface HPC 410 is installed in the appliance and cannot be used as room controller. Ask your contractor for available room controls.



Rule of thumb for outdoor-temp-compensated control with influence of room temperature: the thermostatic valves in the reference room (the room in which the remote control is installed) must be fully open!



The cooling function is not available in Belgium or Denmark.



The cooling menu items mentioned in this manual may be hidden if the installed system is not suitable for cooling.



The electric booster or additional heater are not available for normal operation in Denmark. The heater are however allowed to run in fault mode, for extra DHW and thermal disinfection.

Depending on the software version of the user interface, the texts shown in the display may differ from the texts in these instructions.

The adjustment ranges, default settings and functional scope may differ from the information in these instructions, depending on the system installed at the site.

- If 2 or more heating circuits are installed, settings for different heating circuits are available and are necessary.

1) This setting is not available in Finland or Sweden

- If special system components and modules are installed (e.g. MS 200 solar module, pool module MP 100), corresponding settings are available and necessary.
- If certain types of heat source are installed, additional settings may be available and necessary.

3.1.1 Operation after power failure

At electric power failure or periods with disconnected heat source, no settings are lost. The control unit will restart when the power is restored. It is possible that time and date may need to be reset. No other settings are needed.

3.1.2 Overview of control elements and symbols

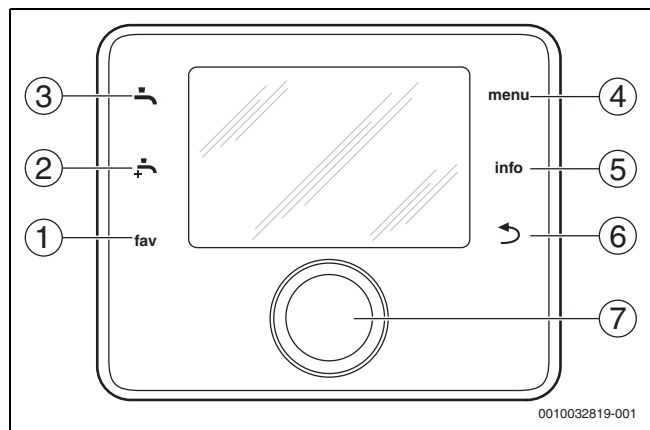

Fig. 4 Control elements

- [1] **fav** key: calls up the favourites menu
- [2] **extra DHW** key: starts extra DHW charging
- [3] **DHW** key: set the operating mode for DHW heating
- [4] **menu** key: main menu (press briefly)
- [5] **info** key: info menu or further information about the current selection
- [6] **↩** key: returns to previous menu or discards a value (press briefly); returns to the standard display (hold down)
- [7] Selector: select (turn) and confirm (press)



If the display lighting is off, only the lighting goes on when the selector is pressed for the first time. When the selector is turned and another control element is pressed at the same time, the lighting is switched on in addition to the effect described. The descriptions of the steps to be carried out by the operator in these instructions always assume that the lighting is activated. If no control element is actuated, the lighting turns off automatically (after approx. 30 s with the standard display, after approx. 30 min in the menu, after 24 h in the event of a fault).

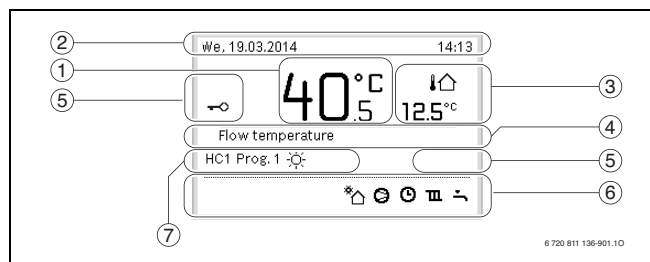























Fig. 5 Symbols in the standard display (example display)



The standard display refers only to the displayed heating circuit. Changing the required room temperature in the standard display only affects the heating circuit displayed.

Item	Symbol	Explanation
1	20.5 °C	Value display (current temperature): <ul style="list-style-type: none"> Room temperature if a remote control is installed for the actual heating circuit. Heat source temperature if there are no remote control installed.
2	-	Info line: display of time of day, day of the week and date.
3		Additional temperature display: outside temperature, temperature of the solar collector or a DHW system.
		For ventilation: display of the ventilation level.
		For ventilation: frost protection (reduced ventilation).
4	-	Text information: e.g. the designation of the temperature currently displayed (→ Fig. 5, [1]). If a fault is present, corresponding information will be displayed here until the fault has been rectified.
5		The key block is active (hold down the DHW key and selector to activate or deactivate the key block).
6		Infographic: solar pump is in operation.
		Infographic: DHW heating is active
		Infographic: DHW thermal disinfection active
		Infographic: Extra DHW active
		Infographic: Pool heating active
		Infographic: Heating active
		Infographic: Cooling active
		Infographic: Energy supplier interruption
		Infographic: External input active (remote)
		Infographic: Holiday mode active
		Infographic: Time program active
		Infographic: Smart grid function active
		Infographic: Screed drying active
		Infographic: Electric booster heater active
		Infographic: Power guard active
		Infographic: Additional heat source active
		Infographic: Defrost function active
	Infographic: Compressor (Heat pump) active	



Item	Symbol	Explanation
7	Op. mode	Operating mode: [Optimised operation] no time program active. Operating mode: [Program 1] [Program 2] automatic mode active (according to time program) for displayed heating circuit.
		Operating mode: heating mode active.
		Operating mode: setback mode active.

Table 2 Symbols in the display

3.2 Control panel

An overview of the structure of the main menu and the position of the individual menu items can be found at the end of this document.

An overview of the items that can be found in the info menu is also found at the end of this document. The info menu is useful to get instant information of the status of the heat pump.

Each of the following descriptions takes the standard display as its starting point (→ Fig. 5).

3.2.1 Switching off

The user interface is powered via the BUS interface and is normally switched on. The system should only be shutdown temporarily, for example when cleaning filters. The complete system is deactivated and there is no frost protection during a shutdown.

- ▶ To temporarily switch off the system:
 - Press and hold the selector until a pop-up menu is displayed.
 - Select **Yes** in the menu **Switch to standby mode?**
- ▶ To switch on the system:
 - Press and hold the selector until a pop-up menu is displayed.
 - Select **Yes** in the menu **Switch from standby mode to normal operation?**



After a prolonged power failure or extended period of idleness, the date and time may need to be reset. All other settings are retained permanently.

3.2.2 Selecting a heating circuit for the standard display

The standard display only ever shows data for one heating circuit. If 2 or more heating circuits are installed, a setting can be made to determine which heating circuit the data in the standard display relates to.

- ▶ Press the selector and turn to select a heating circuit.

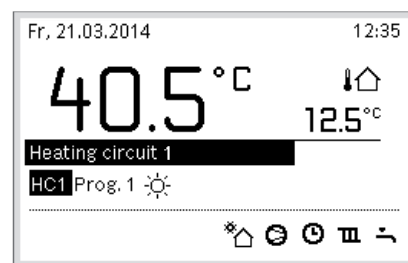

6 720 812 775-02.20

- ▶ Wait a few seconds or press the selector to confirm.

3.2.3 Set operating mode

Activate automatic mode (with time program)

If manual operation is active:

- ▶ Press the **menu** key.
- ▶ Press the selector to open the **Heating** or **Heating/Cooling** menu.
- ▶ Press the selector to open the **Op. mode** menu.
- ▶ Highlight the desired heating circuit and press the selector.
- ▶ Choose **auto** and press the selector.
- ▶ Press and hold the **↵** key to return to the standard display.

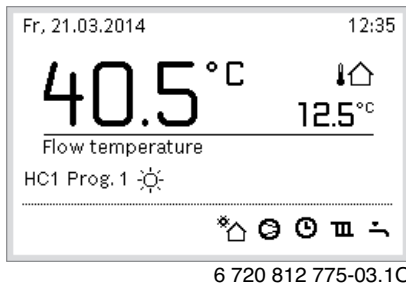

A pop-up window is displayed and the time program is activated. The currently valid temperature flashes.

Activating optimised operation (without time program)

If automatic mode is active:

- ▶ Press the **menu** key.
- ▶ Press the selector to open the **Heating** or **Heating/Cooling** menu.
- ▶ Press the selector to open the **Op. mode** menu.
- ▶ Highlight the desired heating circuit and press the selector.
- ▶ Choose **Optimise** and press the selector.
- ▶ Press and hold the **↵** key to return to the standard display.

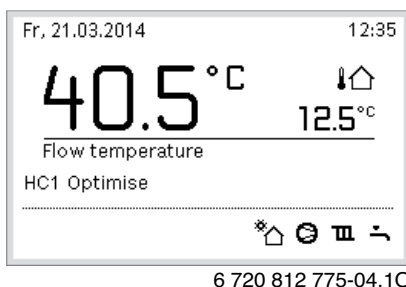

A pop-up window is displayed and the required room temperature is shown.

3.2.4 Changing the room temperature temporarily

Retaining automatic mode

- ▶ Turn and press the selector to set the required room temperature. The corresponding time slot is displayed differently to the other time slots.

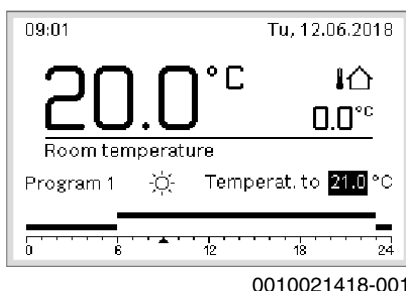

The change applies until the next switching time in the active time program is reached.

Cancelling the temperature change:

- ▶ Turn and press the selector to set the value stored in the time program.

3.2.5 Changing the room temperature permanently

Optimised operation (without time program)

- ▶ Turn and press the selector to set the temperature.

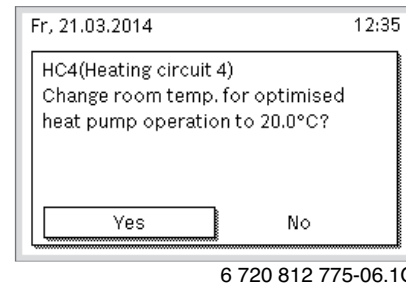

-or-

- ▶ Open the **Heating** or **Heating/Cooling** > **Temperature settings** > **Optimised operation** menu.
- ▶ Select the desired temperature and confirm or select **Heating off** and confirm.

Automatic mode

- ▶ Open the **Heating** or **Heating/Cooling** > **Temperature settings** > **Heating, Setback** or **Cooling** menu.



- ▶ Set the desired temperatures for each mode and confirm, or select and confirm for the **Heating off** setback mode.
- ▶ Assign the operating modes to the required time slots via the time program.

3.2.6 Adapting the heating system settings using the time program (automatic mode)

Open the menu for adapting a time program for the heating system

- ▶ Open the main menu.
- ▶ Open the menu **Heating** or **Heating/Cooling** > **Time program** > **My time program 1** or **2**.

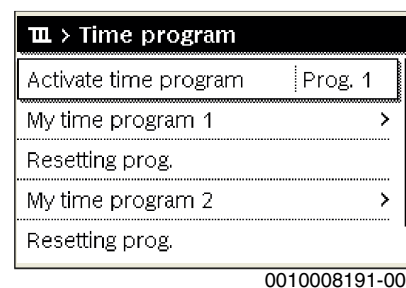

Selecting the day of the week or group of days

- ▶ Open the menu for adapting a time program for the heating system.
- ▶ Press the selector to activate the input field for the day of the week or group of days.
- ▶ Select a day of the week or group of days and confirm.

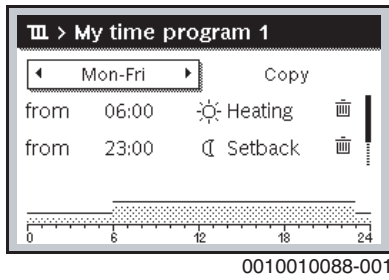

Moving switching time

- ▶ Open the menu for adapting a time program for the heating system.
- ▶ Turn and press the selector to activate the input field for a switching time.
- ▶ Set and confirm the switching time.

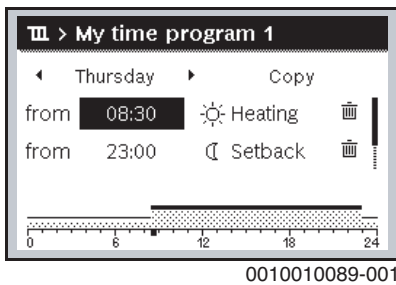

Adjusting the temperature/operating mode for a time slot

- ▶ Open the menu for adapting a time program for the heating system.
- ▶ Turn and press the selector to activate the input field for the operating mode of a time slot.
- ▶ Set and confirm operating mode.

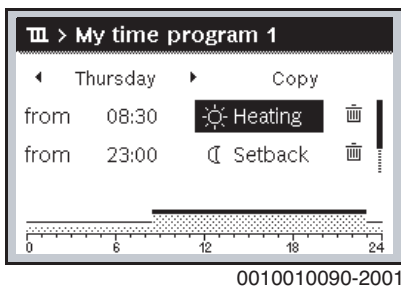

Deleting switching time

- ▶ Open the menu for adapting a time program for the heating system.
- ▶ Select symbol for deleting switching time (trash icon) and confirm.

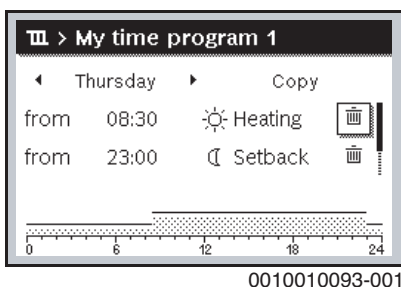

The symbol is associated with the switching time on the same line.

- ▶ Select **Yes** and confirm to delete the switching time. The previous time slot is extended to the next switching time. The switching times are automatically sorted in chronological order.

Copying time program

- ▶ Open the menu for adapting a time program for the heating system.
- ▶ Select the day of the week to be copied, e.g. Thursday.

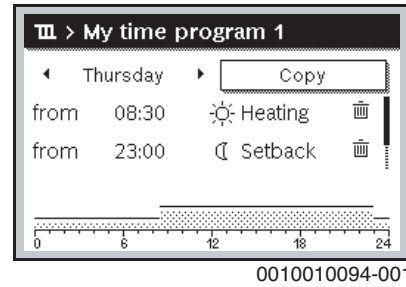

- ▶ Select and confirm **Copy**. A pick list of the days of the week is displayed.
- ▶ Select days (e.g. Monday and Tuesday) that are to be overwritten with the previously selected time program and confirm.

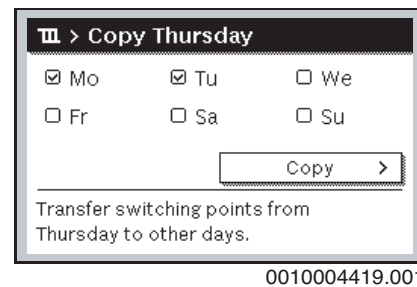

- ▶ Select and confirm **Copy**.

3.2.7 Selecting active time program for the heating system

- ▶ Open the main menu.
- ▶ Open **Heating** or **Heating/Cooling > Time program > Activate time program**.

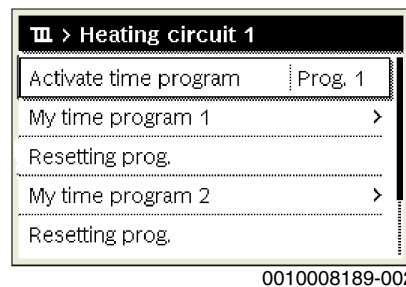

- ▶ Select **My time program 1** or **2** and confirm.

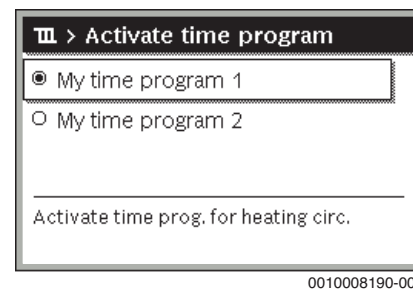

The user interface operates in automatic mode with the selected time program. If 2 or more heating circuits are installed, this setting only applies for the selected heating circuit.

3.2.8 Renaming a time program or heating circuit

Standard designations are preassigned to the time programs and heating circuits.

Open the menu for renaming a time program

- ▶ Open the main menu.
- ▶ Open the **Heating** or **Heating/Cooling** > **Time program** > Heating circuit 1...4 > **Rename time prog.** menu.
The cursor flashes to indicate the start position for data input.

Open the menu for renaming a heating circuit (only available if 2 or more heating circuits are installed)

- ▶ Open the main menu.
- ▶ Open **Heating** or **Heating/Cooling** > **Time program** > **Heating circuit 1** > **Rename heating circuit** menu (or other heating circuit).

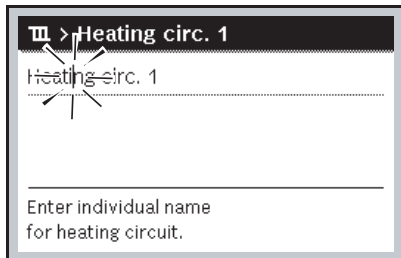

0010008233-001

The cursor flashes to indicate the start position for data input.

Entering/adding characters

- ▶ Open menu for renaming a time program or heating circuit.
- ▶ Turn the selector to position the cursor in the required location.
- ▶ Press the selector to activate the input field (to the right of the cursor).
- ▶ Select character and confirm.

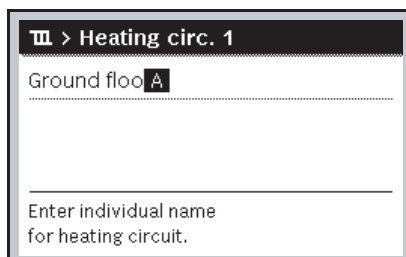

0010008199-001

The selected character is entered (added). The input field for the next character in the text is activated.

- ▶ Press the **↵** key to complete the input.

Deleting characters/resetting name

To delete a character:

- ▶ Open menu for renaming a time program or heating circuit.
- ▶ Place the cursor behind the character to be deleted by turning the selector.
- ▶ Press the selector to activate the input field.
- ▶ Select the character **<C** and confirm.

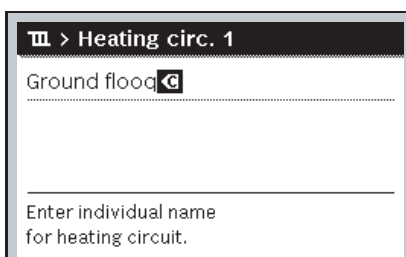

0010008200-001

The character to the left of the input field is deleted.

To reset the name:

- ▶ Delete all characters.
The standard designation is entered again automatically.

3.2.9 DHW settings



When the thermal disinfection function is activated, the DHW cylinder is heated to the corresponding temperature set. The higher temperature hot water can be used for thermal disinfection of the hot water system.

- ▶ Observe regional and local requirements and operating conditions for the DHW circulation pump, including the water quality and instructions of the heat source.

Select the operating mode for DHW heating

Press the DHW key

- ▶ Select and confirm **Always on - DHW Eco+¹⁾**
Lowest DHW temperature mode that results in lowest energy consumption.

-or-

- ▶ **Always on - DHW Eco**
Medium DHW temperature mode that results in medium energy consumption.

-or-

- ▶ **Always on - DHW comfort**
Highest temperature mode that results in higher energy consumption and may also lead to a higher sound level from the system.

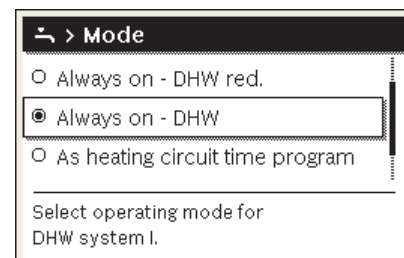

0010008204-001

The DHW temperatures for each mode is set by the installer.

Activate extra DHW cylinder charging

If you have a temporary need of more hot water outside of normal DHW charging or time program:

- ▶ Press the button.
- or-
- ▶ Open the menu DHW > Extra hot water.
- ▶ Set the maximum DHW temperature and duration as desired.
- ▶ Select and confirm **Start now**.

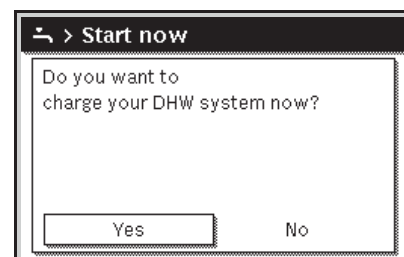

0010008184-001

- ▶ Select **Yes** in the pop-up window and confirm.
- ▶ The water heating becomes active immediately. Once the set duration time has expired, the extra DHW cylinder charging switches off again automatically.

1) Not available for fresh water station.

Open the menu for adapting the time program for DHW heating

- ▶ Open the main menu.
- ▶ Open the **DHW > Time program** menu.
- ▶ Select **Own time program** and confirm.
- ▶ Set switching times and operation modes.

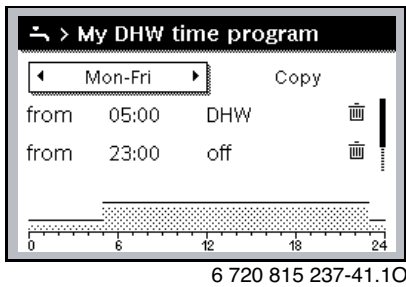

3.2.10 Setting up a holiday program

Open the menu for the holiday program

- ▶ Open the main menu.
- ▶ Open the menu **Holiday > Holiday 1, 2, 3, 4 or 5**.

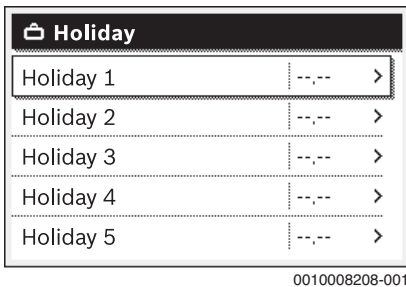

Once the holiday period for the chosen holiday program has been set, the corresponding menu **Holiday 1, 2, 3, 4 or 5** is displayed.

Setting the holiday period

- ▶ Open the menu for the holiday program.
- ▶ If the holiday period for the chosen holiday program has already been set, open the **Holiday period** menu.
- ▶ Select and confirm the day, month and year for **Start:** and **End:** of the holiday period.

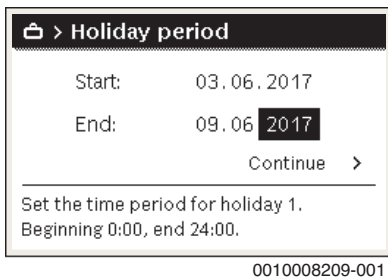

- ▶ To complete the entry, select **Next** and confirm.

Setting the heating and DHW for the holiday program

- ▶ Open the menu for the holiday program.
- ▶ Open the **Selection of htg circ./DHW** menu.

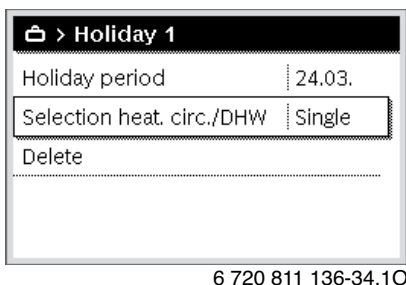

- ▶ Select and confirm the heating circuits and DHW systems.

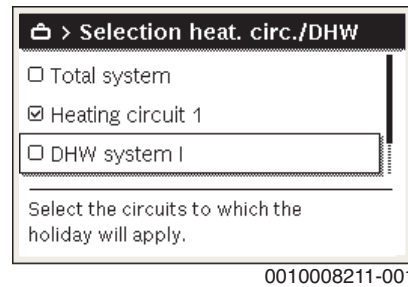

- ▶ The holiday program is valid for the selected heating circuits and DHW systems.
- ▶ To complete the selection, select **Next** and confirm.
- ▶ Check the settings for **Heating** and **DHW** in the menu for the chosen holiday program, and modify if required.

Interrupting a holiday program

During the holiday period, the display indicates until when the holiday program will be active.

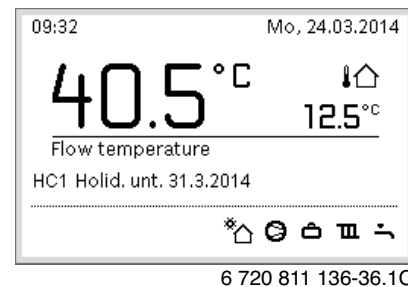

If 2 or more heating circuits are installed, the relevant heating circuit must be selected in the standard display before interrupting the holiday program.

If the holiday program is set to **As Saturday:**

- ▶ Turn the selector and set the desired temperature. The change applies until the next switching time in the active time program is reached.

If no time program is active the holiday program is interrupted by deleting it.

Clearing a holiday program

- ▶ Open the menu for the holiday program.
- ▶ Select and confirm **Delete**.
- ▶ Select **Yes** in the pop-up window and confirm.

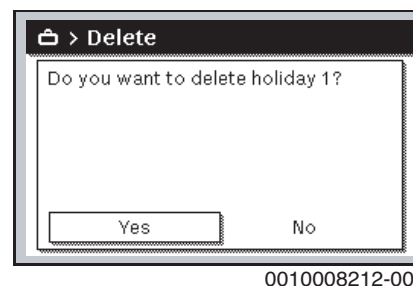

The holiday program is deleted.

3.2.11 More settings

Setting the time and date

If the user interface has been disconnected from the power supply for a prolonged period, the date and time must be set:

- ▶ Restore the power supply.
The user interface displays the setting for the date.

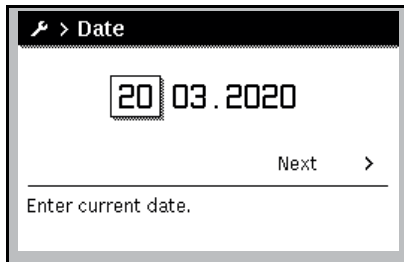

0010003250.002

- ▶ Set the day, month and year respectively and confirm.
- ▶ Confirm **Next**.
The user interface displays the setting for the time.

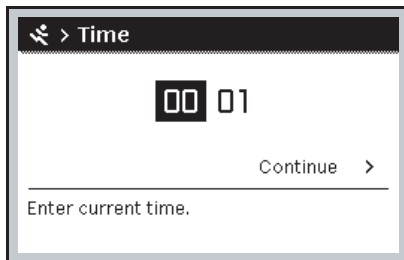

0010003251.001

- ▶ Set the hours and minutes respectively and confirm.
- ▶ Confirm **Next**.
No other settings are required for recommissioning.

Switching the key block on/off

To switch the key block on or off:

- ▶ Press the **selector** and **DHW** key simultaneously until the key symbol in the display appears/disappears.

Setting up the favourite functions

The **fav** key gives direct access to often used functions for heating circuit 1. Press the key once to open the menu.

To adapt the list of favourites in the menu:

- ▶ Press and hold the **fav** key until the configuration menu is displayed.
- ▶ Turn and press the selector to select a function (**Yes**) or to cancel the selection (**No**).
- ▶ Press the **↩** key to close the menu.

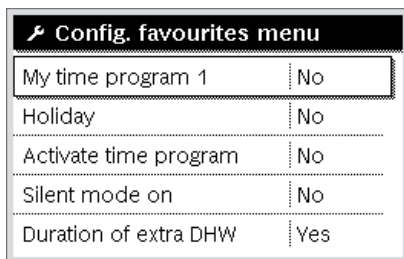

6 720 811 136-15.10

3.3 Main menu

Depending on the heating appliance and how the user interface is used, not all menu items will be available for selection; see overview of main menu at the end of this document.

3.3.1 Heating settings

Menu: **Heating**

Menu item	Description
Op. mode	Select the heating operating mode: optimised or based on time program.
Temperature settings	Temperatures for the levels [Heating], [Setback] or [Optimised operation] can be set in this menu.
Time program	→ see Tab. 5
Summer/winter changeover	→ see Tab. 6
DHW alternating operation	→ see Tab. 7

Table 3 Heating settings

Menu: **Heating/Cooling**

Menu item	Description
Op. mode	Select the heating operating mode: optimised or based on time program.
Temperature settings	Temperatures for the levels [Heating], [Setback], [Optimised operation] or [Cooling] can be set in this menu.
Time program	→ see Tab. 5
Summer/winter changeover	→ see Tab. 6
DHW alternating operation	→ see Tab. 7

Table 4 Heating settings

Adapting the Time program for the automatic mode

Menu: **Time program**

Menu item	Description
Activate time program	Activating automatic mode triggers control of the room temperature according to the settings in the selected time program [My time program 1] or [My time program 2].
My time program 1	2 switching times can be set for each day or group of days. One of the two operating modes (or a temperature) can be assigned to each switching time in automatic mode. The minimum duration of a time slot between two switching times is 15 minutes.
Resetting prog.	The default setting for [My time program 1] can be restored here.
My time program 2	→ See [My time program 1]
Resetting prog.	The default setting for [My time program 2] can be restored here.
Rename time prog.	The names of the time programs can be changed in the same way as the names of the heating circuits. This helps to select the correct time program, e.g. "family" or "night shift".

Table 5 Time program settings for heating

Setting the summer/winter switchover threshold



CAUTION

Risk of system damage!

- ▶ Do not switch over to summer mode if there is a risk of frost.

Menu: **Summer/winter changeover**

Menu item	Description
Heating/Cooling	<ul style="list-style-type: none"> • In summer, heating/cooling mode can be switched off [Continuous summer]. • The heating/cooling mode can be activated/shut down based on the outside temperature (this is only available if the [Automatic mode] is active in the heating circuit). • The heating mode can be active [Continuous heating]. However, heating starts only if it is too cold inside. • The cooling mode can be active [Cooling]. However, cooling starts only if it is too hot inside. <p>If more than one heating circuit is installed, [Heating circuit 1 ... 4] is displayed instead of this menu item.</p>
Heating mode from ¹⁾	If the outside temperature ²⁾ falls below the temperature threshold set here, the heating system is switched on. In systems with more than one heating circuit, this setting always relates to the corresponding heating circuit in each case.
Cooling mode from	If the outside temperature exceeds the temperature threshold set here, the heating system is switched off and cooling is enabled. In systems with more than one heating circuit, this setting always relates to the corresponding heating circuit in each case.

- 1) This menu item is only displayed if the outdoor-temperature-dependent switching between summer and winter modes is active for the heating circuit concerned.
- 2) When the outside temperature is adjusted (damped), changes to the measured outside temperature are delayed and fluctuations reduced.

Table 6 Settings for the summer/winter changeover

Setting the DHW alternating operation

If DHW alternating operation is not activated, DHW heating has priority and interrupts the heat requirement of the heating system, if necessary.

Menu: **DHW alternating operation**

Menu item	Description
DHW alt. operation on	In the event of simultaneous DHW and heating demand, the system will alternate between DHW heating and heating mode based on the times set in [Prioritise DHW for] and [Heating priority for].
Prioritise DHW for	Duration of DHW heating.
Heating priority for	Duration of heating mode.

Table 7 Settings for the DHW alternating operation

3.3.2 DHW settings



Using the extra DHW, thermal disinfection or daily heat up functions can lead to higher electricity cost as the electric booster heater may be activated.



If a fresh water station is installed, setting the DHW temperature ≥ 52 °C can lead to higher electricity cost as the electric booster heater may be activated.

Setting the operation mode for DHW heating

The installer sets the temperatures for the different modes.

Menu: **Op. mode**

Menu item	Description
Op. mode	<ul style="list-style-type: none"> • [Off]: Deactivated, no DHW production. • [Always on - DHW Eco+]¹⁾: Lowest DHW temperature mode that results in lowest energy consumption. • [Always on - DHW Eco]: Medium DHW temperature mode that results in medium energy consumption. • [Always on - DHW comfort]: Highest temperature mode that results in higher energy consumption. • [Own time program]: DHW time program that operates independently of any heating circuit time program.

1) Not available for fresh water station

Table 8 Settings for operation mode of DHW

Setting the time program for DHW heating

Menu: **Time program**

Menu item	Description
My DHW time prog.	Own time program for DHW heating that works independently of the time program for the heating system. 6 switching times can be set for each day or group of days. One of the operating modes can be assigned to each switching time in automatic mode. The minimum duration of a time slot between two switching times is 15 minutes.
Resetting prog.	The time program for the DHW system is reset to the default setting with this menu item.

Table 9 Time program settings for DHW

Activating extra DHW heating

Menu: **Extra hot water**

Menu item	Description
Start now/ Cancel now	After activation of the extra hot water function, DHW is heated for the set duration to the set temperature. When the function is active, [Cancel now] is displayed in the menu. Select this setting for immediate deactivation of the extra hot water function.
Temperature	Desired DHW temperature for the extra hot water function.
Duration	Duration for the extra hot water function. When the time has expired, the function automatically switches off and the system goes back to normal DHW operation.

Table 10 Settings for the extra hot water function

Thermal disinfection



WARNING

Danger to life from legionella!

Legionella can form in domestic hot water at DHW temperatures that are too low.

- ▶ Activate thermal disinfection
- or-
- ▶ Have daily heat-up set in the service menu by the specialist technician.
- ▶ Thermal disinfection may be terminated prematurely due to the system configuration or frequent water extraction. In this case the control unit issues a fault display. When thermal disinfection is activated, attention must be paid to ensuring, that this is performed successfully without a fault display.
- ▶ Observe the statutory regulations on drinking water.



If the thermal disinfection has terminated prematurely a notification is shown in the display. The system will repeat the thermal disinfection 24 hours later.



If the thermal disinfection is set and activated at an external heat source, the settings at the user interface have no effect on the thermal disinfection.



WARNING

Risk of scalding!

If thermal disinfection or the daily heat-up has been activated to avoid legionella, the DHW is heated once to in excess of 60 °C (e.g. Tuesday night at 02:00).

- ▶ Only carry out thermal disinfection/daily heat-up outside normal hours of use.
- ▶ Make sure that a thermal mixer is installed. If in doubt, ask your installer.

Menu: **Autom. therm. disinfect.**

Menu item	Description
Start	The entire DHW volume is automatically heated to the set temperature once a week or daily, if [Auto] is set here.
Start now/ Cancel now	Immediate start or cancellation of thermal disinfection independently of the set day of the week.
Weekday	Day of the week, on which thermal disinfection is automatically carried out once a week, or daily thermal disinfection.
Time of Day	Time of day for the automatic start of thermal disinfection.

Table 11 Settings for thermal disinfection

Setting the DHW alternating operation

If DHW alternating operation is not activated, DHW heating has priority and interrupts the heat requirement of the heating system, if necessary.

Menu: **DHW alternating operation**

Menu item	Description
DHW alt. operation on	In the event of simultaneous DHW and heating demand, the system will alternate between DHW heating and heating mode based on the times set in [Prioritise DHW for] and [Heating priority for].
Prioritise DHW for	Duration of DHW heating.
Heating priority for	Duration of heating mode.

Table 12 Settings for the DHW alternating operation

Settings for the DHW circulation

Menu: **Circulation**

Menu item	Description
Op. mode	<ul style="list-style-type: none"> • [Off]: Circulation is switched off permanently. • [On]: The pump will run according to the settings under [Start frequency]. The time program for the DHW circulation pump is not active. • The circulation can be linked to the time program for DHW heating. • [My circulation time prog.]: Set a time program for the DHW circulation pump that works independently of the time program for DHW.
Start frequency	The start frequency determines how often the DHW circulation pump goes into operation for three minutes at a time every hour (1 x 3 minutes/h ... 6 x 3 minutes/h) or if it is constantly in operation. Whatever the case, circulation is only active during the times set in the time program.
My circulation time prog.	6 switching times can be set for each day or group of days. The DHW circulation pump can be switched on or off at each switching time. The minimum duration of a time slot between two switching times is 15 minutes.
Resetting prog.	The time program is reset to factory default.

Table 13 Settings for the circulation

3.3.3 Settings for the venting function

Menu: **Ventilation**

Menu item	Description
Op. mode	[Select vent. operating mode.] <ul style="list-style-type: none"> • [Sleep] • [High vent. rate] (high ventilation rate) • [Auto (time program)] • [Demand-ctrlled] (demand controlled) • [Ex.air bypass] (exhaust air bypass) • [Party vent.] (party ventilation) • [Firepl.] (fireplace) • [Fan speed 1 ... 4] • [Ventil. switched off] (ventilation off)
Time program	[Enter vent. time program.]
Reset time prog.	[Reset ventilation time program.]
Humidity	[Setting the desired humidity level]: <ul style="list-style-type: none"> • [Dry] • [Normal] • [Moist]
Air quality	[Setting the desired air quality level]: <ul style="list-style-type: none"> • [Adequate] • [Normal] • [High]
Bypass	[Bypass] for more opening hours: <ul style="list-style-type: none"> • [Open] • [Close.]
Supply air temp. control	Set the [Supply air temp.]: <ul style="list-style-type: none"> • [Heating] • [HtgCool] (heating and cooling) • [Cooling] • [Off]
Supply air temp. control (Electric)	Set the [Supply air temp.]: <ul style="list-style-type: none"> • [Heating] • [Off]
Reheat supp.air temp.	[Set the desired supply air temp. of reh. bank.] 10 ... 22 ... 30 °C
Filter timer	[Set the time in months until the next filter change.] 1 ... 6 ... 12 Months
Confirm filter change	The filters in the ventilation unit must be changed. Please confirm the filter change.
Rename ventil. zone	The names of the ventilation zones can be changed in the same way as the names of the heating circuits. This helps in choosing the right ventilation zone.

Table 14 Ventilation settings

3.3.4 Setting up a holiday program

Menu: **Holiday**



CAUTION

Risk of system damage!

- ▶ Before a prolonged period of absence, only change the settings under **Holiday**.
- ▶ After a long absence, check the operating pressure of the heating system and check the pressure gauge of the solar system if applicable.
- ▶ Do not switch off the solar system during long absences.



Cooling mode will not be activated during a holiday program.

Menu: **Holiday 1, Holiday 2, Holiday 3, Holiday 4 and Holiday 5**

Menu item	Description
Holiday period	Set the start and end date of the absence during holiday: the holiday program starts at the set start time at 00:00 o'clock. The holiday program ends at the set end time at 24:00 o'clock.
Selection of htg circ./DHW	The holiday program is applied to the sections of the system highlighted here. Only the heating circuits and DHW systems actually installed in the system are available for selection.
Heating	Control of the room temperature for the selected heating circuits during the holiday period: <ul style="list-style-type: none"> • Any [Constant temperature] can be set for the selected heating circuits throughout the entire holiday period. • The [Off] setting deactivates the heating system completely for the selected heating circuits.
DHW	DHW settings for the selected DHW systems during the holiday period. <ul style="list-style-type: none"> • If [Off] is set, no DHW at all will be available during the holiday period. • If [Off + therm. disinfection on] is set, DHW heating is deactivated but thermal disinfection is still carried out as normal either once a week or once a day. Note: If the holiday is spent at home, the DHW systems must not be selected under [Selection of htg circ./DHW] to ensure DHW remains available.
Delete	Delete all settings for the selected holiday program

Table 15 Settings for holiday programs

3.3.5 Settings for other systems or devices

If other specific systems or devices are installed in the system, additional menu items will be available. Depending on which system or device is being used and the associated assemblies or components, various settings can be made. Observe the additional information on the settings and functions in the technical documentation for the relevant system or device.

Settings for a swimming pool

Menu: **Pool**

Menu item	Description
Switch on pool heating	This setting enables the pool heating when it is activated.
Pool temperature	The water in the pool is heated to this temperature.
Allow add. heater for pool	This setting allows the auxiliary heater to supply heating for the pool if the heat pump cannot reach the set temperature.

Table 16 Settings for pool heating

Settings for smart grid

This menu is only available if a smart grid system is installed.

Menu item	Control range: Function description
Heating	The energy available in the smart grid is used for heating, if the system is in heating mode. [Selectable peak]: 0...5 °C Set how much the room temperature may be increased. [Forced peak]: 2...5 °C Set how much the room temperature is forced to increase.
DHW	The energy available in the smart grid is used for DHW. [Selectable peak]: [Yes] [No] If enabled the DHW is heated to the temperature set for DHW operating mode [Always on - DHW comfort]. No heating is done if the holiday program is active.

Table 17 Settings in the smart grid data menu

Settings for a photovoltaic system

Make the photovoltaic (PV) specific settings in this menu. Select if the available energy should be used for Heating or DHW.

If photovoltaic energy is available and a buffer cylinder is installed with all heating circuits mixed, the buffer cylinder will be heated to the heat pump maximum temperature.

Menu: **PV system**

Menu item	Control range: Function description
Heating peak	The energy available in the PV system is used for heating, if the system is in heating mode. Set how much the room temperature may be increased 0...5 °C.
DHW peak	The energy available in the PV system is used for DHW. [Yes] [No] If enabled the DHW is heated to the temperature set for DHW operating mode [Always on - DHW comfort]. No heating is done if the holiday program is active.
Cooling setback mode	The energy available in the PV system is used for cooling. [Yes] [No] If enabled the room temperature is decreased to the temperature set for cooling operating mode. No cooling is done if the holiday program is active.
Only cool with PV	Cooling mode is activated only if energy is available in the PV system. [Yes] [No] If enabled the room temperature is decreased to the temperature set for cooling operating mode. No cooling is done if the holiday program is active.

Table 18 Settings in the PV system data menu

Settings for the energy manager

Make the energy manger (EM) specific settings in this menu.

Menu: **Energy manager**

Menu item	Control range: Function description
Heating peak	The energy available in the energy management system is used for heating, if the system is in heating mode. Set how much the room temperature may be increased 0...5 °C.
Only cool with EM	Cooling mode is activated only if energy is available in the energy management system. [Yes] [No] If enabled the room temperature is decreased to the temperature set for cooling operating mode. No cooling is done if the holiday program is active.

Table 19 Settings in the EM system data menu

3.3.6 General Settings

Menu: **Settings**

Menu item	Description
Language	Language of the display texts
Time format	Switch the format for display of the time of day between 24-hour and 12-hour format.
Time of Day	Set actual time. All time programs and thermal disinfection run according to this time.
Date format	Change the format of the date.
Date	Set actual date. The holiday program, for example, runs based on this date. The current day of the week is also determined based on this date; this affects the time programs and thermal disinfection, for example.
Auto. time switchover	Activate or deactivate the automatic changeover between summer and winter time. If [Yes] is set, the time of day is automatically changed (from 02:00 to 03:00 on the last Sunday in March and from 03:00 to 02:00 on the last Sunday in October).
Display contrast	Change the contrast (for improved clarity).
Warning sound blocked	If a buzzer has been installed a warning sound is emitted as soon as an alarm occurs. The warning sound can be suppressed at a settable time interval.
Reduced DHW temp.	Setting for the reduced DHW mode. If [Yes] is set, the DHW temperature is reduced if there are a compressor fault. The function is used to reduce the use of the auxiliary heater.
DHW temp. correction	Correction of the DHW temperature displayed by the user interface by up to ± 10 °C.
Time correction	Time correction of the internal clock of the user interface in s/week.
Standard display	Settings for the display of additional temperatures in the standard display.
Internet password	Reset the personal password for the Internet connection (only available if a communication module is installed). The next time you log in, e.g. using an App, you will automatically be prompted to assign a new password.
Internet	Make settings for the Internet connection (only available if a communication module is installed). <ul style="list-style-type: none"> • [Establish connection] <ul style="list-style-type: none"> - [Pairing-Status] - [Activate hotspot] - [Activate WPS] • [Terminate connection] <ul style="list-style-type: none"> - [Connected network] - [Terminate connection]
Low-noise operation	If activated the heat pump will run in reduced sound operation during the set time period. <ul style="list-style-type: none"> • [Low-noise operation of]: set the start time for the low noise operation. • [Low-noise operation until]: set the stop time for the low noise operation. • [Min. outside temp.]: Below this outdoor temperature the heat pump switches over to normal operation.
Reset	Reset all settings to the values set at commissioning.

Table 20 General Settings

3.4 Calling up information about the system

The current system values and the active operating conditions can be displayed easily via the info menu. No changes can be made in this menu.

To open the info menu:

- Press the **info** key in the standard display.

Menu: **Sum./winter changeover**

Menu item	Description
Heating/cooling mode	Currently valid operating mode in the selected heating circuit.
Set room temp.	The desired room temperature that is currently valid in the selected heating circuit: <ul style="list-style-type: none"> • In automatic mode, this can change several times a day, if necessary. • In normal operation, it is always constant.
Measured room temp.	Currently measured room temperature in the selected heating circuit
Measured flow temp.	Currently measured flow temperature in the selected heating circuit

Table 21 Information about the heating

Menu: **DHW**

Menu item	Description
Set temp.	Desired DHW temperature.
Measured temp.	Currently measured DHW temperature.

Table 22 Information about DHW

Menu: **Ventilation**

Menu item	Description
Op. mode	Currently selected operating mode and ventilation level
Outside temperature	Display of Outside temperature
Supply air temp.	Display of supply air temperature
Ex.air temp.	Display of extract air temperature
Exhaust air temp.	Display of exhaust air temperature
Reheat supp.air temp.	Display of supply air temperature from the re-heater
Ex.air humid.	Display of exhaust air humidity
Ex.air quality	Display of exhaust air quality
Humidity remote ctrl	Display of humidity in the installation room of the remote control
Amb. air humid.	Display of ambient air humidity
Amb. air quality	Display of ambient air quality
Bypass	Display of bypass-settings
Rem. filter elapsed time	Display of duration in days until the next filter change time

Table 23 Information about the ventilation unit

Menu: **Pool**

Menu item	Description
Set pool temperature	Desired pool temperature.
Current pool temperature	Currently measured pool temperature.

Table 24 Information about pool

Menu: **Operating data**

Menu item	Description
Control operating hours	Hours run by the control since the heat pump was commissioned or since the last reset.
Aux. heater energy cons.	Output of the electric booster heater since commissioning or since the last reset.
Op. hours for comp. heat.	Hours run by the compressor in heating mode since commissioning or since the last reset.
Op. hours for comp. cool.	Hours run by the compressor in cooling mode since commissioning or since the last reset.
Op. hours for comp. DHW	Hours run by the compressor in DHW operation since commissioning or since the last reset.
Op. hours for comp. pool	Hours run by the compressor in pool operation since commissioning or since the last reset.
Number of heating starts	Number of compressor starts in heating mode since commissioning or since the last reset.
Number of cooling starts	Number of compressor starts in cooling mode since commissioning or since the last reset.
Number of DHW starts	Number of compressor starts in DHW operation since commissioning or since the last reset.
Number of pool starts	Number of compressor starts in pool operation since commissioning or since the last reset.

Table 25 Operation data

Menu: **Energy consump.**

Menu item	Description
Total	Cumulated total energy consumed by the heating system.

Table 26 Total energy consumption data

Menu: **Energy consump. > Electric auxiliary heater**

Menu item	Description
Total	Cumulated total energy consumed by the electric booster heater.
Heating	Cumulated energy consumed by the electric booster heater in heating mode.
DHW	Cumulated energy consumed by the electric booster heater in DHW mode.
Pool	Cumulated energy consumed by the electric booster heater in pool heating mode.

Table 27 Energy consumption data for electric booster heater

Menu: **Energy consump. > Compressor**

Menu item	Description
Total	Cumulated total energy consumed by the heat pump.
Heating	Cumulated energy consumed by the heat pump in heating mode.
DHW	Cumulated energy consumed by the heat pump in DHW mode.
Cooling	Cumulated energy consumed by the heat pump in cooling mode.
Pool	Cumulated energy consumed by the heat pump in pool heating mode.

Table 28 Energy consumption data for heat pump

Menu: **Energy supplied**

Menu item	Description
Total energy suppl.	Cumulated total energy output of the heat pump.
Heating energy suppl.	Cumulated energy output of the heat pump in heating mode.
DHW energy suppl.	Cumulated energy output of the heat pump in DHW mode.
Emitted cooling energy	Cumulated energy output of the heat pump in cooling mode.
Pool energy suppl.	Cumulated energy output of the heat pump in pool heating mode.

Table 29 Energy output data for heat pump

Menu: **Solar**

Menu item	Description
Solar sensor (graphic)	Current measured temperatures with display of position of the selected temperature sensor in the solar system hydraulics (with graphic visualisation of the current operating conditions of the actuators in the solar system).
Solar yield	Solar yield for last week, solar yield for current week and total yield of solar system since the solar system was commissioned.

Table 30 Information about the solar system

Menu: **Outdoor temp**

The currently measured outside temperature is displayed in this menu. In addition, a diagram of the outside temperature profile for today and yesterday (from 00:00 to 24:00 in each case) is displayed here.

Menu: **Internet**

Menu item	Description
IP connection	Status of the connection between communication module and router.
Server connection	Status of the connection between communication module and Internet (via the router).
Connected network	Status of the connection between communication module and the network and display of WLAN-SSID.
IP address	IPV4 address of the communication module.
SW version	Software version of the communication module.
Login data	Login name and password for the login into the App to operate the system via a smartphone.
MAC address	MAC address of the communication module.

Table 31 Information about the Internet connection

3.5 Faults

If a fault persists:

- ▶ Confirm the fault by pressing the selector.
- ▶ Faults that are still active are displayed by pressing the ↵ key.
- ▶ Call an authorised contractor or customer service and give them the fault code and sub-code, as well as the ID no. of the user interface.



Table 32 Your contractor must enter the ID no. here.

Faults on additional heat source:

- ▶ Check the display of the additional heat source for information.
- ▶ Reset the additional heat source.
- ▶ If the fault persists; contact your contractor.

4 Maintenance



The heat source is connected to high current.

Grave personal injuries may occur.

- ▶ Disconnect the power supply before rectifying.



Using the wrong cleaning product may damage the units!

- ▶ Do not use acid or chlorine based products or products that contain abrasives.

4.1 Indoor unit

Check the following items a few times each year:

- ▶ System pressure
- ▶ Particle filter
- ▶ Moist in cooling mode
- ▶ Safety valves

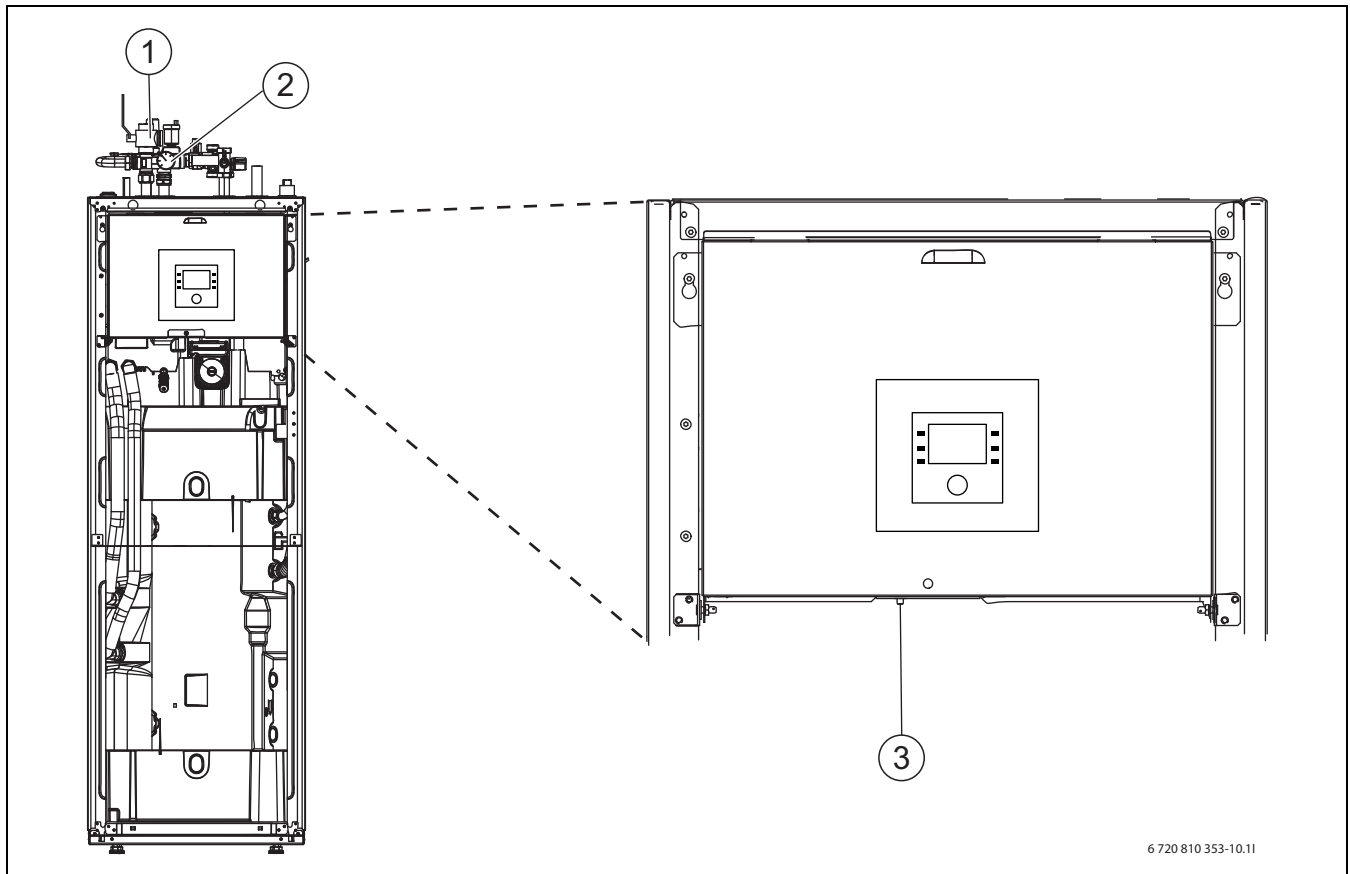

Fig. 6 Indoor unit AWM / AWMS

- [1] Particle filter
- [2] Pressure gauge
- [3] Reset overheating protection

4.1.1 Check system pressure

- ▶ Check the pressure on the pressure gauge.
- ▶ If the pressure is lower than 0.5 bar, slowly increase the pressure in the heating system by adding water through the filling valve to a maximum of 2 bar.
- ▶ Contact your installer or reseller if you are insecure how to perform the filling.

4.1.2 Particle filter

The filter prevents particles and contamination from entering the heat pump. Over time, the filter can become blocked and must be cleaned.



To clean the filter, the system does not need to be emptied. The filter and shut-off valve are integrated.

Cleaning the strainer

- ▶ Close the valve (1).
- ▶ Unscrew the cap (manually) (2).
- ▶ Take out the strainer and clean it by running water over it or by pressure cleaning.
- ▶ Reinstall the strainer. For proper assembly, make sure that the guide bumps fit into the recesses in the valve.

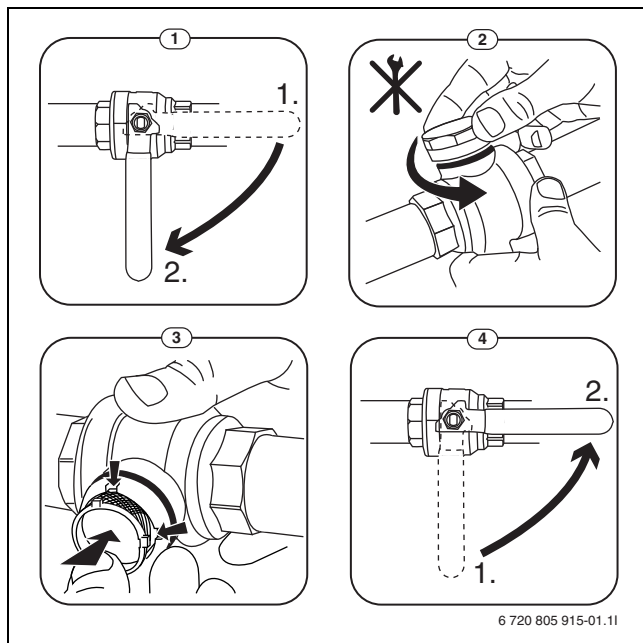

Fig. 7 Cleaning the strainer

- ▶ Screw the cap back on (tighten handtight).
- ▶ Open the valve (4).

Check the magnetite indicator

After installation and startup the magnetite indicator must be checked at more frequent intervals. If a lot of magnetic dirt is clinging to the magnetic bar in the particulate filter and that dirt frequently causes an alarm related to the poor flow (e.g., low or poor flow, high flow supply or HP alarm) a magnetite filter must be installed to avoid regular draining of the indicator. A filter also increases the longevity of components in the heat pump as well as the remaining parts of the heating system.

4.1.3 Overheating protection



The overheating protection must be reset manually if it has tripped.

To reset the overheating protection on AWM or AWMS:

- ▶ Pull out the front cover by the bottom and lift it off upwards.
- ▶ Press the button hard on the overheating protection.
- ▶ Put the front cover back.

4.1.4 Moisture in cooling mode

NOTICE

Insufficient condensate insulation

Moist near the components of the heating system.

- ▶ Shut off the heating system and contact retailer/installer if moist or condensate is found near any of the heating system components.

4.1.5 Checking the safety valves



The safety valves should be checked 1-2 times each a year.



Water is expelled from the safety valve during heat-up. Never close the safety valve.

- ▶ The safety valve should only let water out if the maximum pressure is exceeded. Contact the installer if water is coming from the safety valve at pressures below 2 bar.
- ▶ The drainage hose from the safety valve shall be discharged into the sewage / floor well.

4.2 Heat pump (outdoor unit)

The following inspection and maintenance steps are carried out several times per year in order that the heat pump's maximum output will be maintained:

- ▶ Housing (casing)
- ▶ Cleaning of the evaporator
- ▶ Snow and ice
- ▶ Cleaning of the condensation catch pan

4.2.1 Housing (casing)

Dust and other dirt particles concentrate in the heat pump's outdoor unit over time.

- ▶ Remove dirt and leaves from the heat pump with a brush.
- ▶ If required, clean the outside with a damp cloth.
- ▶ Spot repair cracks and damage on the casing with anti-corrosive paint.
- ▶ Standard car wax can be applied to protect the paint.

4.2.2 Evaporator

Any layers of dust or dirt, for example, deposited on the surface of the evaporator must be removed.



CAUTION

The aluminium fins are thin and sensitive.

They can be damaged easily due to careless handling.

- ▶ Never use hard objects.
- ▶ Never rub the fins directly with a cloth.
- ▶ Wear protective gloves.
- ▶ Never use water pressure that is too high.

Cleaning of the evaporator:

- ▶ Spray detergent on the evaporator fins on the back of the heat pump.
- ▶ Rinse off coatings and detergent with water.



In some regions, washing-up liquid must not be flushed into gravel beds. If the condensate tube discharges into a gravel bed:

- ▶ Remove the flexible condensate tube from the drain pipe prior to cleaning.
- ▶ Collect the washing-up liquid in a suitable container.
- ▶ Reconnect the condensate tube after cleaning.

4.2.3 Snow and ice

In certain geographical regions or during periods of heavy snow, snow can get stuck on the back and the roof of the heat pump. Make sure to clear the snow to prevent icing-up.

- ▶ Carefully brush the snow off the fins.
- ▶ Clear the snow off the roof.
- ▶ Hot water can be used to rinse off the ice.

Moisture can form under the heat pump due to condensate not falling into the condensation catch pan. This is normal and no special action is required.

If the heat pump has sound insulation, ice can form. In this case there is risk of falling.

4.2.4 Cleaning of the condensation catch pan

If the control unit displays the alarm that the heat pump needs to be cleaned, remove the dirt particles and leaves that impair the de-icing function from the condensation catch pan.

 **WARNING**

The evaporator's aluminium fins are thin and sensitive.

The fins have sharp edges. Risk of cuts in the event of careless handling.

- ▶ Wear protective gloves on your hands to protect against cuts.
- ▶ Proceed with caution in order not to damage the fins.

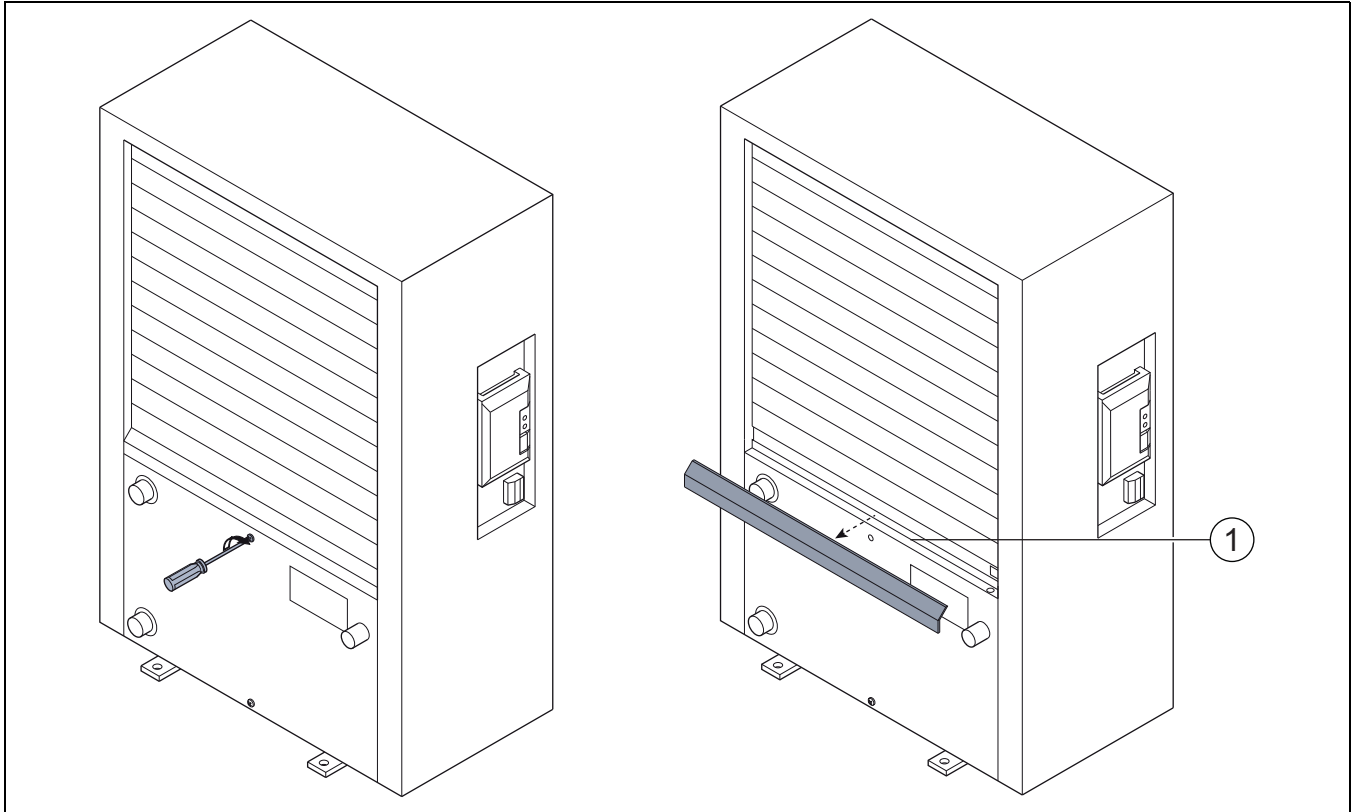

Fig. 8 The heat pump condensation catch pan

[1] Drain pan

4.3 Connection option for the IP module

i The IP module is installed as standard in a number of products and can be retrofitted to others as an accessory.

i To take advantage of all the functions, an Internet connection and router with a free RJ45 output are necessary. This can lead to additional costs. The **Bosch HomeCom Easy** app is required to control the system using a mobile phone. Functionality is not available in all national markets. For further information please contact Technical Support.

The IP module can be used to control and monitor the system via a mobile device. It is used as an interface between the heating system and a network (LAN) and also enables the SmartGrid function.

Commissioning

i When commissioning, refer to the router documents.

The router must be configured as follows:

- DHCP active
- Ports 5222 and 5223 must not be blocked from outgoing traffic.
- Free IP address available
- Address filtering adapted to the module (MAC filter).

The following options exist for commissioning the IP module:

- Internet

The IP module automatically obtains an IP address from the router. The name and address of the target server are stored in the factory settings of the module. Once an Internet connection is established, the IP module automatically logs on to the Bosch server.

- LAN

The module does not have to have Internet access. It can also be used in a local network. In this case, the heating system cannot be accessed through the Internet, and the IP module software is not automatically updated.

- App **Bosch HomeCom Easy**

When starting the app for the first time, you will be asked to enter the login name and password set at the factory. These login details are printed on the data plate of the IP module.

- SmartGrid

With SmartGrid, the indoor unit can communicate with the energy exchange and modify the operation of the heat pump so that it is at the maximum output when the price for the power is the most affordable. For details of the SmartGrid, refer to the product website.

i The login data are lost when the IP module is exchanged.

Each IP module has its own login data.

- ▶ After commissioning, enter the login data in the corresponding field of the user instructions.
- ▶ After exchanging, replace with the data for the new IP module.

i Alternately, the password can be changed at the control device.

Login data for the IP module

Manuf. no.: _____
 Login name: _____
 Password: _____
 Mac: _____

4.4 Information on refrigerant

This device **contains fluorinated greenhouse gases** as a refrigerant. The unit is hermetically sealed. The following information on the refrigerant complies with the requirements of EU Regulation No. 517/2014 on fluorinated greenhouse gases.

i Notice for the user: If your installer adds refrigerant, he enters the added fill volume and the total amount of the refrigerant in the following table.

Unit designation	Refrigerant type	Global warming potential (GWP) [kgCO ₂ eq]	CO ₂ equivalent of the original fill volume [t]	Original fill volume [kg]	Added fill volume [kg]	Total amount on commissioning [kg]
5	R410A	2088	3.550	1.700		
7	R410A	2088	3.654	1.750		
9	R410A	2088	4.907	2.350		
13	R410A	2088	6.890	3.300		
17	R410A	2088	8.352	4.000		

Table 33 Information on refrigerant

5 Environmental protection and disposal

Environmental protection is one of the fundamental company policies of the Bosch Group.

We regard quality of products, economy and environmental protection as equal objectives. Environmental protection laws and regulations are strictly adhered to.

To protect the environment, we use the best possible technology and materials taking economic aspects into account.

Packaging

Where packaging is concerned, we participate in country-specific recycling processes that ensure optimum recycling.

All of our packaging materials are environmentally compatible and can be recycled.

Used appliances

Used appliances contain valuable materials that can be recycled.

The various assemblies can be easily dismantled. Synthetic materials are marked accordingly. Assemblies can therefore be sorted by composition and passed on for recycling or disposal.

Old electrical and electronic appliances



This symbol means that the product must not be disposed of with other waste, and instead must be taken to the waste collection points for treatment, collection, recycling and disposal.

The symbol is valid in countries where waste electrical and electronic equipment regulations apply, e.g. "European Directive 2012/19/EC on old electronic and electrical appliances". These regulations define the framework for the return and recycling of old electronic appliances that apply in each country.

As electronic devices may contain hazardous substances, it needs to be recycled responsibly in order to minimize any potential harm to the environment and human health. Furthermore, recycling of electronic scrap helps preserve natural resources.

For additional information on the environmentally compatible disposal of old electrical and electronic appliances, please contact the relevant local authorities, your household waste disposal service or the retailer where you purchased the product.

You can find more information here:
www.weee.bosch-thermotechnology.com/

6 Data Protection Notice



We, **Bosch Thermotechnology Ltd., Cotswold Way, Warndon, Worcester WR4 9SW, United Kingdom** process product and installation information, technical and connection data, communication data, product registration and client history data to provide product functionality (art. 6 (1) sentence 1 (b)

GDPR), to fulfil our duty of product surveillance and for product safety and security reasons (art. 6 (1) sentence 1 (f) GDPR), to safeguard our rights in connection with warranty and product registration questions (art. 6 (1) sentence 1 (f) GDPR) and to analyze the distribution of our products and to provide individualized information and offers related to the product (art. 6 (1) sentence 1 (f) GDPR). To provide services such as sales and marketing services, contract management, payment handling, programming, data hosting and hotline services we can commission and transfer data to external service providers and/or Bosch affiliated enterprises. In some cases, but only if appropriate data protection is ensured, personal data might be transferred to recipients located outside of the European Economic Area. Further information are provided on request. You can contact our Data Protection Officer under: Data Protection Officer, Information Security and Privacy (C/ISP), Robert Bosch GmbH, Postfach 30 02 20, 70442 Stuttgart, GERMANY.

You have the right to object, on grounds relating to your particular situation or where personal data are processed for direct marketing purposes, at any time to processing of your personal data which is based on art. 6 (1) sentence 1 (f) GDPR. To exercise your rights, please contact us via privacy.ttgb@bosch.com To find further information, please follow the QR-Code.

7 Technical terms

Heat pump (outdoor unit)

The central heat source. Installed in the open air. Alternative designation: outdoor unit. Contains the cooling circuit. Heated or cooled water is channeled from the outdoor unit to the heat pump module (indoor unit).

Indoor unit

Installed in the building and distributes the heat from the outdoor unit to the heating system or the DHW cylinder. Contains the control unit and the pump in the heat transfer medium line for the outdoor unit.

Heating installation

Designation for the entire installation, comprising the heat pump, heat pump module, DHW cylinder, heating system and accessories.

Heating system

Comprises the heat source, container, radiators, underfloor heating system or fan convectors or a combination of these elements if the heating system is made up of several heating circuits.

Heat. circ.

The part of the heating system that distributes the heat throughout the various rooms. Consists of pipework, pump and radiators, heating hoses of the underfloor heating system or fan convectors. Only one of the specified alternatives is possible within a circuit. However, if for example the heating system is equipped with two circuits, radiators can be installed in one and an underfloor heating system installed in the other. Heating circuits can be configured with and without mixers.

Heating water/domestic hot water

If domestic hot water is connected to the system, a distinction is made between heating water and domestic hot water. The heating water is channeled to the radiators and the underfloor heating system. Shower and water taps are supplied with domestic hot water.

If a DHW cylinder is present in the system, the control unit switches between heating and DHW mode so that maximum comfort is achieved. The DHW or heating mode can be prioritised by selecting an option on the control unit.

Heating circuit without mixer

In a heating circuit without mixer the temperature in the circuit is controlled purely by the energy from the heat source.

Heating circuit with mixer

In a heating circuit with mixer, the mixer mixes return water from the circuit with water from the heat pump. This allows heating circuits with mixer to be operated at a lower temperature than the other heating system, e.g. so that underfloor heating systems that operate at lower temperatures can be separated from radiators that require higher temperatures.

Mixer

The mixer is a valve that steadily mixes colder return water with hot water from the heat source in order to achieve a specific temperature. The mixer can be situated in a heating circuit or in the heat pump module for the external auxiliary heater.

3-way valve

The 3-way valve distributes thermal energy to the heating circuits or the DHW cylinder. It has two defined settings so that heating and DHW

heating cannot occur at the same time. This is also the most effective operating mode, as the DHW is always heated to a specific temperature, while the heating water temperature is continuously adjusted to the outdoor air temperature in each case.

External auxiliary heater (extra)

The external auxiliary heater is a separate heat source which is connected via pipework to the indoor unit. The heat produced in the auxiliary heater is controlled via a mixer. It is therefore also referred to as an auxiliary heater with mixer. The control unit controls the activation and deactivation of the auxiliary heater according to the existing heat energy demand. Heat sources are electric, oil-fired or floor standing gas boilers.

Heat transfer medium circuit

The part of the heating system that transports the heat from the outdoor unit to the indoor unit.

Cooling circuit

The main part of the outdoor unit that obtains energy from the outdoor air and transfers this as heat to the heat transfer medium circuit. Consists of evaporator, compressor, condenser and expansion valve. The refrigerant circulates in the cooling circuit.

Evaporator

Heat exchanger between air and refrigerant. The energy from the air that is drawn in through the evaporator causes the refrigerant to boil and turn to gas as a result.

Compressor

Moves the refrigerant through the cooling circuit from the evaporator to the condenser. Increases the pressure of the gaseous refrigerant. The temperature also increases as the pressure increases.

Condenser

Heat exchanger between refrigerant in the cooling circuit and water in the heat transfer medium circuit. During the heat transfer, the temperature of the refrigerant falls as it changes into the liquid aggregation state.

Expansion valve

Reduces the pressure of the refrigerant after it is discharged from the condenser. The refrigerant is then channeled back to the evaporator where the process starts again.

Inverter

Located in the outdoor unit and enables the speed of the compressor to be controlled based on the heat energy demand in each case.



Setback phase

A period during the time-controlled operation involving the **setback** operating mode.

Time-controlled operation

The heating system is heated in accordance with the time program and switching between the operating modes occurs automatically.

Operating phase

The heating operating phases are: **heating** and **setback**. They are depicted by the symbols  and .

The operating phases for DHW heating are: **DHW**, **DHW reduced** and **Off**. A temperature can be set for each operating phase (except for **Off**).

Frost protection

Depending on the type of frost protection selected, the outdoor unit is switched on if the outside temperature or room temperature falls below a certain critical threshold. Frost protection prevents the heating system from freezing up.

Desired room temperature

The room temperature to be achieved by the heating system. It can be set individually.

Default settings

Values saved permanently on the control unit, which are available at all times and can be reset as necessary.

Heating phase

A period during the time-controlled operation involving the **heating** operating mode.

Parental lock

Settings in the standard display and in the menu can only be changed if the parental lock (key block) is switched off.

Mixer/mixing valve

Assembly that automatically ensures that DHW can be drawn from the draw-off points at a temperature no higher than the temperature set on the mixing valve.

Normal Operation

In normal mode, automatic mode (the heating system time program) is not active and the home is steadily heated at the temperature set for normal mode.

Reference room

The room in your home where the remote control is installed is the reference room. The room temperature in this room acts as the control variable for the assigned heating circuit (which can include several rooms or the entire house if only one circuit is present).

Switching time

A particular time when the heating temperature, for example, is increased or reduced. A switching time is a component of a time program.

Temperature during an operating phase

A temperature that is assigned to an operating phase. The temperature is adjustable. Refer to the explanations about the operating mode.

Flow temperature

The temperature that the heating water in the heating circuit retains from the heat source through to the radiators or the underfloor heating system in the room.

Hot water cylinder

A DHW cylinder stores large volumes of heated potable water. Sufficient hot water is available at the draw-off points (e.g. water taps) as a result.

Time program for heating

This time program ensures automatic switchover between the operating phases at defined switching times.

8 Overview Main menu

This is an overview of all possible menu items. In each installation only menus of installed modules or components are shown.

Heating or Heating/Cooling

- Op. mode
- Temperature settings
 - Heating
 - Setback
 - Optimised operation
 - Cooling
- Time program
 - Activate time program
 - My time program 1
 - Resetting prog.
 - My time program 2
 - Resetting prog.
 - Rename time prog.
- Summer/winter changeover
 - Heating
 - Summer mode from
 - Op. mode
 - Cooling mode from
- DHW alternating operation
 - DHW alt. operation on
 - Prioritise DHW for
 - Heating priority for

DHW

- Op. mode
- Time program
 - My DHW time prog.
 - Resetting prog.
- Extra hot water
 - Start now
 - Cancel now
 - Temperature
 - Duration
- Autom. therm. disinfect.
 - Start
 - Start now
 - Cancel now
 - Temperature
 - Weekday
 - Time of Day
- DHW alternating operation
 - DHW alt. operation on
 - Prioritise DHW for
 - Heating priority for
- Circulation
 - Op. mode
 - Start frequency
 - My circulation time prog. (circulation time program)
 - Resetting prog. (reset circulation time program)

Ventilation

- Op. mode
- Time program
- Reset time prog.

- Humidity
- Air quality
- Bypass
- Supply air temp. control
- Reheat supp.air temp. (After-heater supply air temperature)
- Filter timer
- Confirm filter change
- Rename ventil. zone

Pool

- Switch on pool heating
- Pool temperature
- Allow add. heater for pool

Holiday

Smart grid

- Heating
 - Selectable peak
 - Forced peak
- DHW
 - Selectable peak

PV system

- Heating peak
- DHW peak
- Cooling setback mode
- Only cool with PV
- Max. output for compr.

Energy manager

- Heating peak
- Only cool with EM

Settings

- Language
- Time format
- Time of Day
- Date format
- Date [DD.MM]
- Auto. time switchover
- Display contrast
- Warning sound blocked
 - Warning sound blocked
 - Warn. sound blocked by
 - Warn. snd. blocked until
- Reduced DHW temp.
- DHW temp. correction
- Time correction
- Standard display
- Internet password
- Internet
 - Establish connection
 - Terminate connection
- Low-noise operation
 - Low-noise operation
 - Low-noise operation of
 - Low-noise operation until

- Min. outside temp.
- Reset
 - Reset settings

9 Overview Info

This is an overview of all possible information. In each installation only information of installed modules or components are shown.

Heating or Heating/Cooling

- Heating/cooling mode
- Set room temp. (set room temperature)
- Measured room temp. (measured room temperature)
- Measured flow temp. (measured flow temperature)

DHW

- Set temp. (set DHW temperature)
- Measured temp. (measured DHW temperature)

DHW (Fresh water station)

Ventilation

- Op. mode
- Outside temperature
- Supply air temp.
- Ex.air temp.
- Exhaust air temp.
- Reheat supp.air temp. (Reheater supply air temperature)
- Ex.air humid.
- Ex.air quality
- Humidity remote ctrl
- Amb. air humid.
- Amb. air quality
- Bypass
- Rem. filter elapsed time

Pool

- Set pool temperature
- Current pool temperature

Operating data

- Control operating hours
- Aux. heater energy cons.
- Op. hours for comp. heat.
- Op. hours for comp. cool.
- Op. hours for comp. DHW
- Op. hours for comp. pool
- Number of heating starts
- Number of cooling starts
- Number of DHW starts
- Number of pool starts

Energy consump.

- Total
- Electric auxiliary heater
 - Total
 - Heating

- DHW
- Pool
- Compressor
 - Total
 - Heating
 - DHW
 - Cooling
 - Pool
- 24h: ventil. current
- 30d: ventil. current

Energy supplied

- Total energy suppl.
- Heating energy suppl.
- DHW energy suppl.
- Emitted cooling energy
- Pool energy suppl.

Solar

- Solar sensor
- Solar yield

Outdoor temp

- Outside temp. curve
- Outdoor temp
- Wireless outside temp.

Internet

- IP connection
- Server connection
- Connected network
- IP address
- SW version
- Login data
- MAC address

System information (Only active limitations are shown, otherwise the menu is empty)

- Heat pump status
 - Compressor off. Too cold
 - Comp. off. Too warm
 - Max. air intake temp.
 - Min. air intake temp.
 - Cool. mode off. Too cold
 - Cool. mode off. Too warm
 - Max. temp. reached
 - Heat p. off: Low fl. temp.
 - Warm-up phase
 - Max. add. heater temp.
 - Anti-seizure mode
 - Insuff. DHW flow rate
- Cooling circuit status
- Compressor output
- Additional heater status
- Elec. boost. heater output
- Status aux heater with mix
 - Add. heat source
 - Mixing valve
- El. DHW additional heater

- ESC block
 - PV system
 - Smart grid
 - Current operation
 - COP heat source
-

TECHNICAL SUPPORT: 0330 123 3366
RENEWABLE SUPPORT: 0330 123 9229
CONTROLS AND CONNECTIVITY TEAM: 0330 123 3641
APPOINTMENTS: 0330 123 9339
SPARES: 0330 123 9779
LITERATURE: 0330 123 9119
TRAINING: 0330 123 0166
SALES: 0330 123 9669

Bosch Thermotechnology Ltd.
Cotswold Way, Warndon
Worcester WR4 9SW
United Kingdom
Tel. 0330 123 9559
worcester-bosch.co.uk

